

DO IT YOURSELF PACKET

Fitted Trap Covers

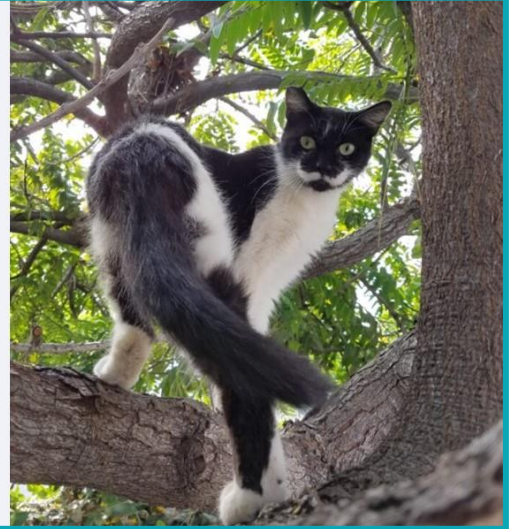

Thank you for your interest in helping the animals at San Diego Humane Society! We would not be able to provide the level of care and commitment to our animals without the help of people like you.

This *Do-It-Yourself* packet includes a sewing pattern for fitted cat traps that we could use for our Community Cat Program. These covers will reduce fear, anxiety and stress as the community cats are transported to our shelter to receive their vaccinations, spay/neuter and ear tip procedures, then are returned back to their communities of origin. For more information on our Community Cat Program, [click here](#).

Credit for pattern: [Fix Nation](#)

Verification of Hours:

A Volunteer Log is included on the next page if needed for service hours. Please bring the completed log when dropping off items at the shelter and an employee will verify and sign for the service hours. To request as hours verification letter, please email a copy of your log to volunteercenter@sdhumane.org.

Item Drop Off:

You may drop off items at any of our campuses Tuesday-Sunday from 10:00am-6:00pm:

San Diego
5500 Gaines Street

El Cajon
1373 N. Marshall Ave.

Escondido
3500 Burnet Drive

Oceanside
572 Airport Rd



Volunteer Hours Log

Please list all volunteer hours completed. We will sign off on up to 15 hours of service each month.

Your Name: _____

Email: _____

Date	Time	Task	Please explain how you completed this project
		TOTAL HOURS	Thank you for volunteering!

Staff Use Only

San Diego Humane Society Acknowledgment of Donation/Service:

Signature: _____

Printed name and title: _____ Date: _____

How to Make Cat Trap Covers



TOOLS:

- 1 single needle sewing machine
- 1 pair of paper scissors
- 1 pair of fabric scissors
- 1 box of fabric pins OR fabric weights (can of tuna works)
- 1 No 2 pencil
- 1 fabric pen, chalk (you can use the pencil too)
- 1 yard stick OR ruler
- (if you don't like scissors you can use a rotary tool and a cutting mat)

MATERIAL:

Paper: Roll of butcher paper, roll of brown shipping paper, cardboard, or scratch paper taped together to make a large sheet. Be creative, this will be for the pattern.

Fabric: used bedsheets, towels, shower curtains, etc

Thread spool: the industrial size spools if you can get it, polyester is best

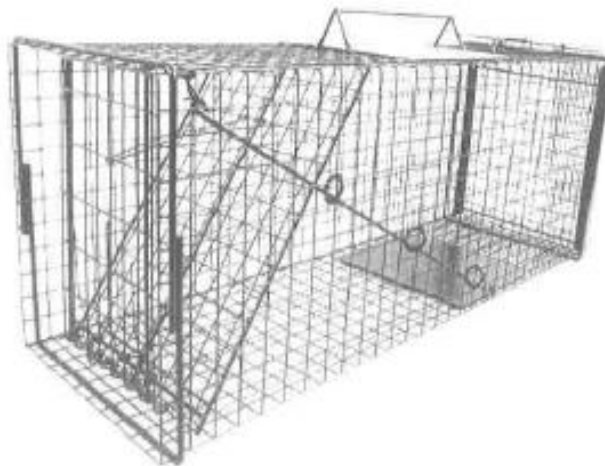



STEP 1: DRAFT PATTERN

One-Piece Pattern

Follow the diagram with the measurements to draft your pattern. This is not to scale.

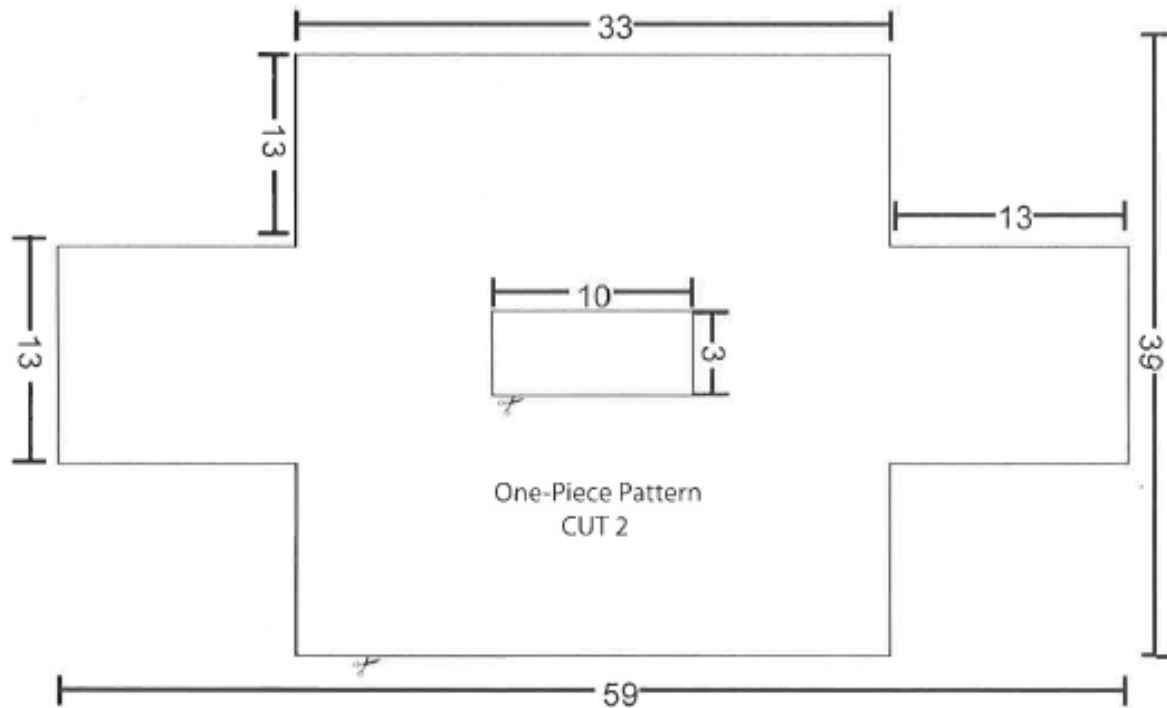

STEP 1: DRAFT PATTERN (continued)

Two-Piece Pattern

Follow the diagrams with the measurements to draft your pattern. This is not to scale. Make sure you make notches. If you do not have a notcher, fold the paper and cut a v-shape, this will help with tracing later.

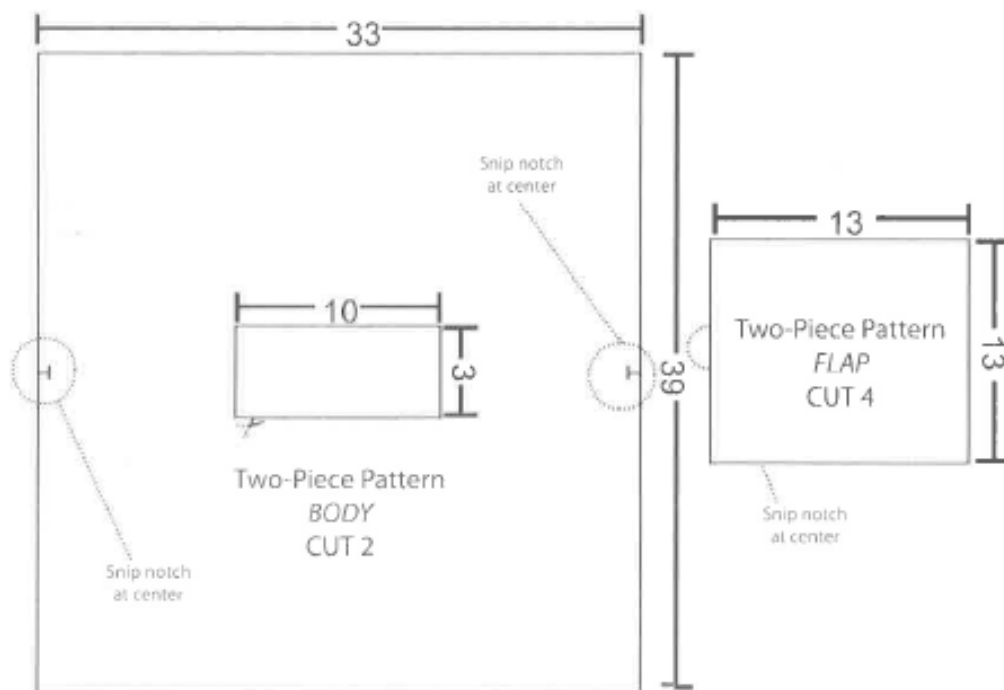

Facing

The facing pattern is for the hole of the trap handle and is meant to be used with towels, where a handle hole has been cut in the middle of the towel.

Follow the diagrams with the measurements to draft your pattern.

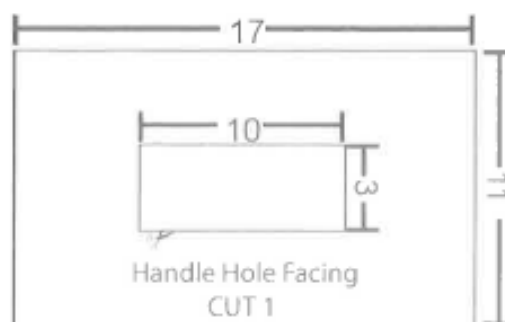



STEP 2: CUTTING FABRIC

Before starting please wash all fabric, remove from dryer immediately to prevent any wrinkles. This will save time if you don't want to iron anything.

- (a) Lay fabric flat, face to face, smoothing out any wrinkles, follow the rules for folded edges & hemmed edges under "Cutting Rules"
- (b) Place pattern on the fabric and trace it with fabric chalk or fabric pen, a pencil works as well. Do not use a Sharpie, not only will it leak through the fabric onto your cutting surface, it will also ruin your pattern. Use weights or pins if needed.
- (c) Pin and cut within the traced line, the straighter you cut the easier it will be to sew later. Pins can be substituted for weights.
- (d) Fold each cut set, for ease of sewing later, its best to fold each set together.

One-Piece Pattern Cover (Cut 2)

Example:

Cut 2 – Body, bedsheet A & B

Two-Piece Pattern Body (Cut 2) Flap (Cut 4)

Example:

Cut 2 – Body, bedsheet A & B

Cut 4 - Flap, bedsheet A & B



STEP 2: CUTTING FABRIC (continued)

Cutting Rules:

Cut as straight as possible

Match edges as precisely as possible

Place folded edges along the length of the pattern

Place hemmed edges along the length of the pattern

For pillow cases, place the pattern at a corner with cut edges to be at one side and the top that connects to the body of the cover

ALWAYS ALIGN PATTERNS PARRALEL WITH THE FABRIC EDGE. In other words the length of the pattern should align with the length of the fabric, do not skew it, this will cause the fabric to stretch during the sewing process.



STEP 2: CUTTING FABRIC (continued)

Bedsheets, thin fabric

Bedsheets are the easiest to sew. When choosing fabrics, make sure both sheets are of similar weight and stretch for each trap cover. When you use similar fabrics in one cover, the sewing will go by much faster. For example, do not use a thin light weight polyester fabric with a medium weight 100 % cotton sheet, the stretch may be different and may cause difficulty when sewing later.

Example, Two piece pattern:

Cut 2 – Body, bedsheet A & B

Cut 4 - Flap, bedsheet A & B

Towels

Please refer to the facing pattern for the handle. Towels can be used as is as long as they cover the majority of the trap. To make the trapping process a little easier, cut a hole for the handle using your pattern. In a thinner fabric cut the facing for the handle.

Example, towel with facing:

Cut 1 - Towel with handle hole

Cut 1 – Facing for the handle hole

Old Blankets, thick fabrics

If you want to use old blankets you should cut one using a thicker fabric and cut one using a thinner fabric (bed sheet).

Example, One piece pattern:

Cut 1 – Body of cover, blanket

Cut 1 – Body of cover, bed sheet

STEP 3: SEWING

One-Piece Patterns:

- (1) Sew with $\frac{1}{2}$ " seam allowance all around, pivot at corners.
Leave 10" opening on one side
- (2) Prepare corners (see Figure 1)
 - (a) Fold convex corners
 - (b) Snip to points at concave corners
- (3) Flip cover
- (4) From 10" opening pull handle hole while holding the seams as if finished, sew all around with $\frac{1}{2}$ " seam allowance. Pivot at corners reducing stitch length to size-1 (or smaller). See Page 10 for more details.
- (5) Snip corners of handle hole, flip
- (6) Iron cover if desired
- (7) Sew $\frac{1}{4}$ " top stitch all around cover and handle holes
- (8) DONE (see Figure 2)

Figure 1

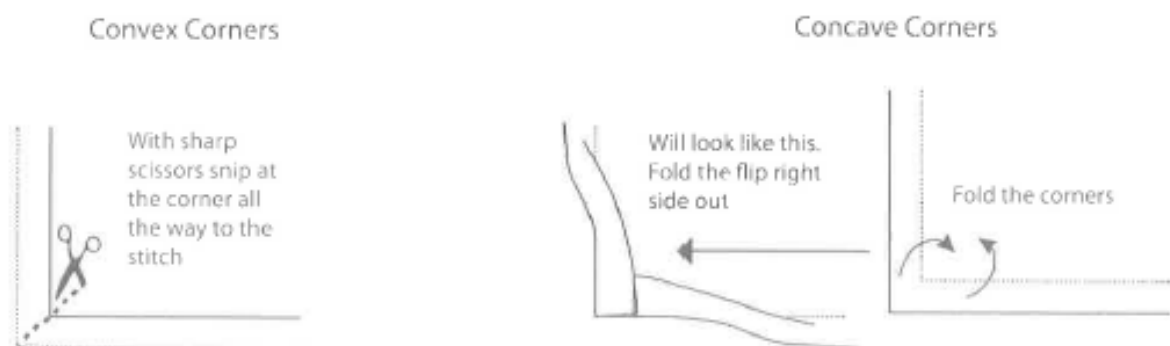

STEP 3: SEWING (continued)

Figure 2

Finished Cover made from One-Piece Pattern

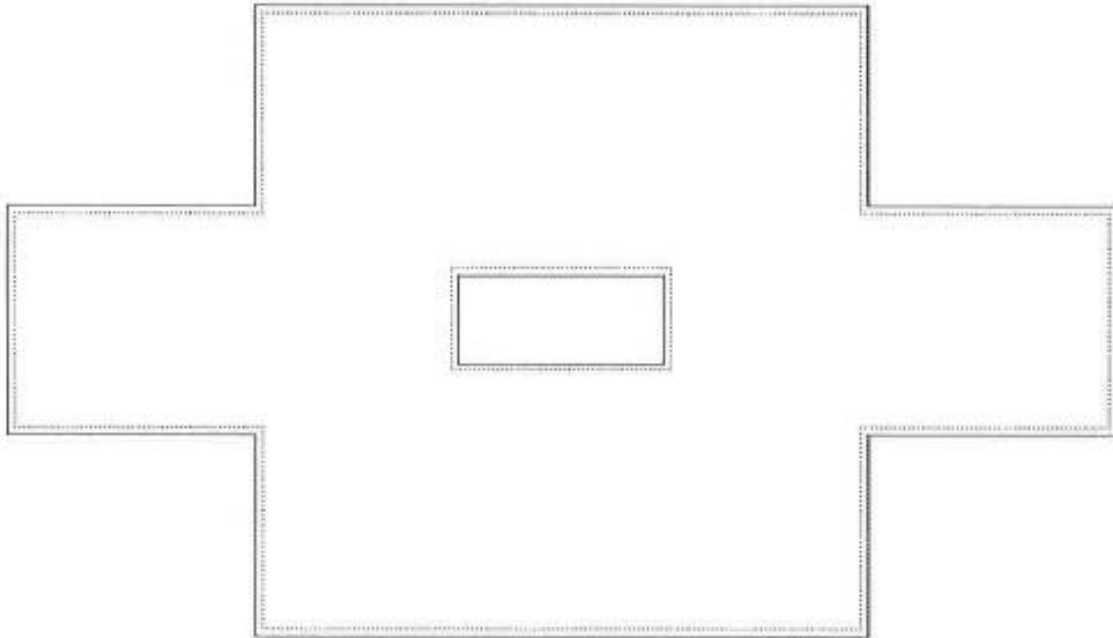

Finished Cover made from Two-Piece Pattern

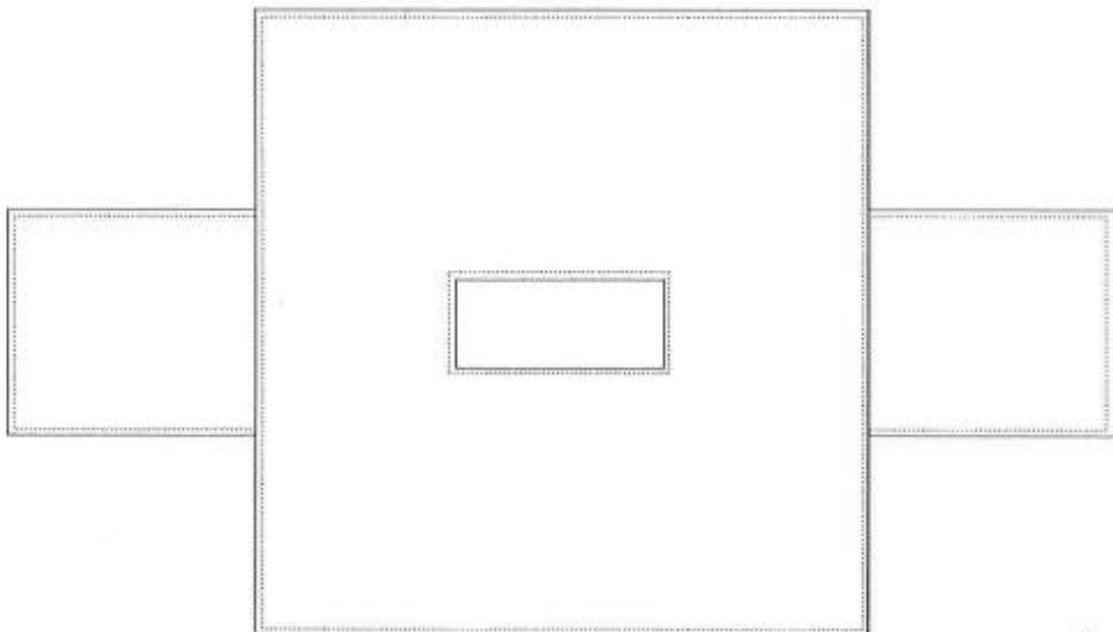

STEP 3: SEWING (continued)

Two-Piece Pattern

- (1) Start with the Flaps, place fabric face to face, sew on three sides with $\frac{1}{2}$ " seam allowance (sides without the notch)
- (2) Fold corners, flip flaps, sew $\frac{1}{4}$ " top stitch on the same three sides
- (3) For Body place fabric face to face, match notches on body to the notch on the flaps, pin flaps in place (see Figure 3)
- (4) After pinning, sew $\frac{1}{2}$ " seam allowance all around, pivot at corners, leave 10" opening.
- (5) Fold corners, flip
- (6) From 10" opening pull handle hole while holding the seams as if finished, sew all around with $\frac{1}{2}$ " seam allowance. Pivot at corners reducing stitch length to size-1 (or smaller). See Page 10 for more details.
- (7) Snip corners of handle hole, flip
- (8) Iron cover if desired
- (9) Sew $\frac{1}{4}$ " top stitch all around body and handle holes
- (10) DONE (see Figure 2)

Figure 3

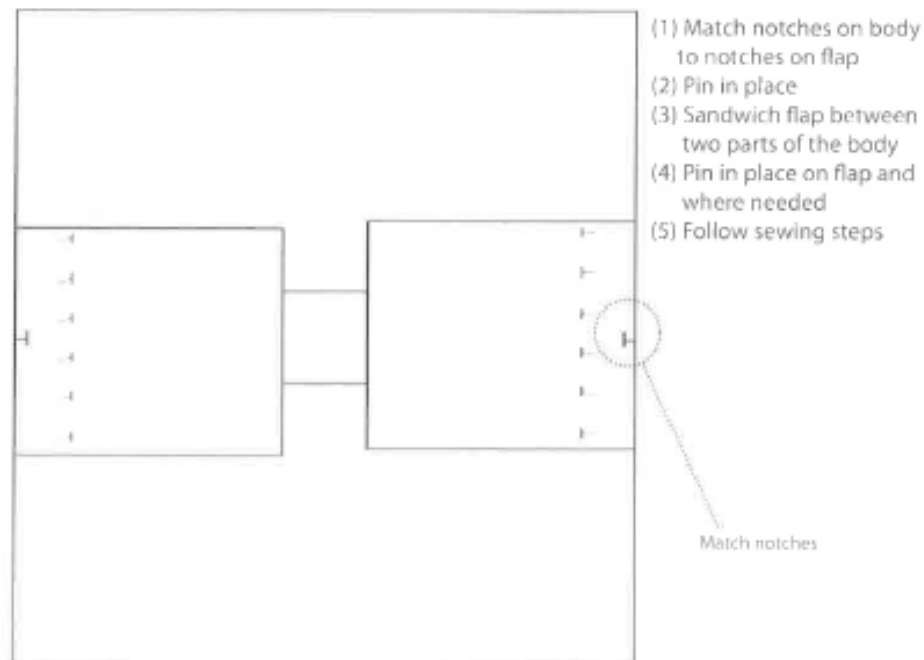

STEP 3: SEWING (continued)

Basic Handle Holes

These instructions provide further details than listed above, with a step-by-step breakdown.

This is a long lasting method, intermediate to advanced level.

- (1) Once you have sewn the body of the cover and have flipped it, make sure the opening of the handle hole is aligned
- (2) Through the 10" opening, grab the raw edges of handle hole as if finished, make sure the corners match. Pin if needed
- (3) Sew with 1/2" seam allowance (advance sewers can sew at 1/4")
- (4) Pivot at corners reducing stitch length to size-1 (or smaller)
- (5) Snip at corners, flip cover right side out
- (6) DONE

Handle Hole Facing

These are the handle hole sewing steps for those who want to do a facing instead.

This is a long lasting method, intermediate level.

- (1) Place the handle hole facing on to the cover, face to face, making sure that the squares are aligned. Pin if needed.
- (2) Sew 1/4" seam allowance all around, pivot at corners, reducing stitch length to size-1 (or smaller)
- (3) Snip to the stitch at corners (see Figure 3)
- (4) Flip facing to opposite side, iron if desired
- (5) Top stitch with 1/4" seam allowance
- (6) DONE (see Figure 4)

EASY Handle Holes

The steps listed above may be too advance or confusing for you. Here is the easy no-brainer way.

This is not as long lasting as the previous method, but fast and easy.

- (1) After flipping, ironing, and topstitching the cover, make sure the handle hole matches perfectly
- (2) Using a single needle OR zigzag, topstitch the handle hole with 1/4" seam allowance. Make two to three passes
- (3) DONE (see Figure 4)

Figure 4

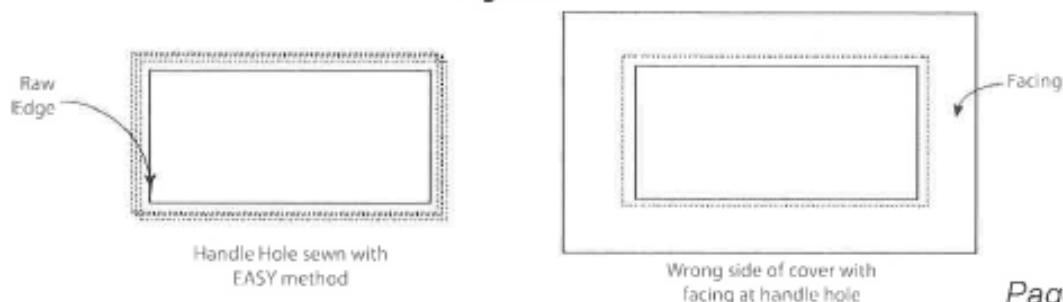



STEP 4: LABELS (Optional)

To ensure that the cat trap covers you lovingly made are kept with the cat traps, the covers should be labeled.

Below is a list of iron-on transfer sheets listed alphabetically by brand. You can find these types of products online at Amazon and Ebay and at brick & mortar stores like Michael's and Joann's, local art & craft stores may also have other brands not listed (Swains, Blue Rooster). I prefer the opaque white sheets meant for darker fabrics, they absorb the ink much better than their transparent counterparts and last much longer through many washes.

Avery: Personal Creations InkJet Iron-On Dark T-Shirt Transfers, White

Epson: Iron-On Inkjet Transfer, White

Jane Tailor: Dark T-Shirt Transfer, Iron-On Transfer Sheets

Transfer Magic: Ink Jet Transfer to Dark, Transfer Paper For Dark Fabrics

World Paper: Jet-Opaque II Iron on Heat Transfer Paper/Dark Color 8.5x11

World Paper: 3G Jet Opaque Inkjet Heat Transfer Paper 8.5x11

Once you've purchased your transfer sheets please print the last page included in this PDF. Follow the instructions on the transfer sheet package. I prefer to place my labels on one of the corners, but placement is at your discretion.

Have fun!

